

CO₂ MONITOR 1200P

Instruction Manual

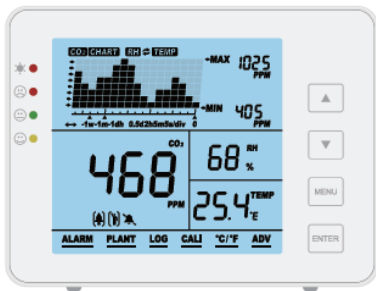

Reproduction of part or all of the contents of this document in any form is expressly prohibited other than for individual use only. Subject to modifications and errors.
All text, images and labels are property of nimax GmbH.

Table of contents

First steps	2
Packing list	2
Functions at a glance	2
Overview	3
Operation and settings	4
Instruction Manual	4
LCD monitor	5
Trend chart display	6
Max/Min	7
Functions in the main menu	8
Specifications	13
Annex	15

First steps

Thank you for your purchase!

This product can be used to monitor the CO₂ concentration, relative humidity, temperature and room air quality.

Packing list

CO₂ monitor unit

USB cable for power supply

User manual

Functions at a glance

Large display

Functions of the push-buttons

15° angled construction for easy reading

Low-drift NDIR sensor with long service life

Acoustic alarm

Diagram with variable time zoom levels

CO₂/RH/temperature monitor tracer





Auto calibration and manual calibration

Max/Min value display over a set time

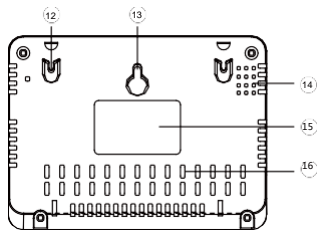
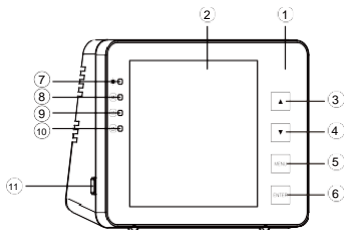















Overview

Monitor sketch and component list



Item	Description	Item	Description
1	Front side	9	Good value
2	LCD	10	Low value
3	 button	11	USB port
4	 button	12	Hole for wall mounting
5	 button	13	Hole for screws
6	 button	14	Buzzer grille
7	Operating display	15	Label
8	High value	16	Holes for sensors

Operation and settings

- Use the USB cable supplied to connect up the device. The device is ready for operation as soon as the countdown reaches zero. See p. 3.
- Press   to switch between time axis and CO2/RH/TEMP. The trend chart shows the recorded values over time for each of the three parameters. See p. 5.
- Reset to factory settings: Hold  pressed for 3 seconds until an acoustic signal sounds.
- Press  once to display the main menu. Press  /  to select the desired function. See p. 7.
- Press  to switch between Persons  and Plants mode . See p. 8.
- Press  to change the high/low alarm limits for persons  and plants . See p. 11.
- Press  to switch from loud  to mute . See p. 8.
- Press  to select °C or °F for the temperature display. See p. 11.

Instruction Manual

1. Plug in the device using the USB cable supplied as shown on the right.
2. After connection, the operating display and the 3 LEDs flash in turn.
3. The main display shows a countdown. You can use the product as soon as the countdown has reached zero. NO CALIBRATION necessary.

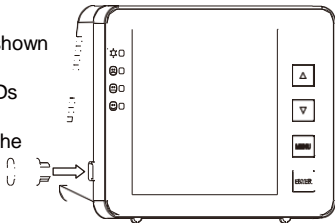

LCD monitor

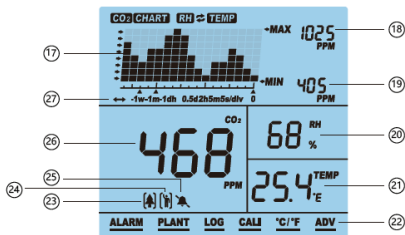

Item	Name	Item	Name
17	CO2/RH/TEMP chart	23	Plants mode
18	Max. value of the chart	24	Persons mode
19	Min. value of the chart	25	Acoustic alarm ON/OFF
20	RH (relative humidity)	26	CO2 value in ppm
21	TEMP (Temperature in °C / °F)	27	Displays the timeline of the chart
22	Main menu		

Trend chart display

The trend chart displays the measured values to date for each of the three parameters (CO₂/RH/Temp). There are 4 modes that can be selected with the  button: CO₂, TEMP, RH and “Cycle symbol” (-> alternates automatically between CO₂/Temp/RH).

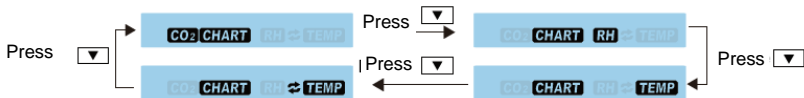
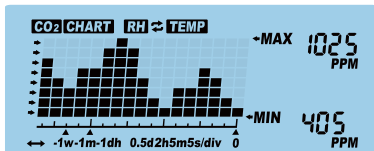

Press  to switch between the available zoom levels for each parameter (minute/hour/day/week)

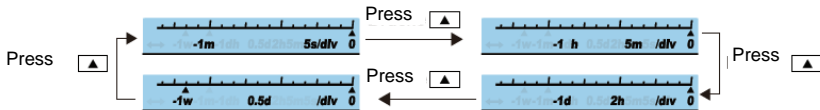





The available zoom levels for all the parameters CO2/RH/Temp and the increments in the different levels can be seen in the table below:

Zoom level (time interval)	Time per increment
1M (minute)	5 sec/increment
1H (hour)	5 m/increment
1D (day)	2 h/increment
1W (week)	0.5 d/increment

Max/Min

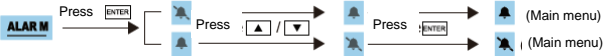
Two numerical indicators can be seen in the top right-hand corner of the display: MAX and MIN. When the zoom level is changed, the MAX and MIN values reflect the highest and lowest values in the table for the selected parameter (CO2, RH and Temp).

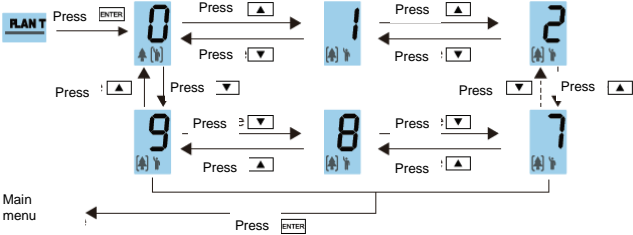
To select a function, press **ENTER** while it is underlined by the flashing cursor. Note that if no button is pressed within 1 minute, the main menu disappears and the device returns to normal mode.

Function	Description
ALARM	 <p>If ALARM  is displayed, an acoustic alarm will sound as soon as the CO2 value reaches the high or low limit.  means mute</p>
PLANT	 <p>0 is the default setting for Persons mode. The default alarms for low and high values lie at 800 and 1200 ppm. Press “ADV” to change these settings, if necessary. To activate Plants mode, select one of the numbers 1-9 by pressing . A description of the numbers and the respective plant types can be found on p. 14.</p>

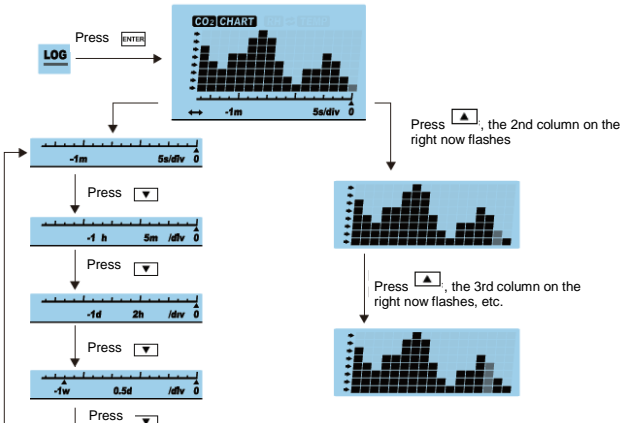
Function	Description
LOG	 <p>Press LOG → Press ENTER → CO₂ CHART (5s/div)</p> <p>Press ↓ → (-1m 5m/div)</p> <p>Press ↓ → (-1h 2h/div)</p> <p>Press ↓ → (-1d 0.5d/div)</p> <p>Press ↓ → (-1w /div)</p> <p>Press ↑ (2nd column on the right row flashes)</p> <p>Press ↑ (3rd column on the right row flashes, etc.)</p> <p>This function allows you to view historical data sets.</p>

Function	Description
CALI	<p>Press ENTER → 400 <small>CO₂ ppm</small> <small>(CO₂ level display)</small></p> <p>[Hold ENTER pressed for 3 seconds until an acoustic signal sounds] → 250 <small>(Temperature display)</small></p> <p>→ 249 → → Main menu</p> <p>Press ENTER to go back</p>
	<p>Place the device in front of an open window or outdoors for at least 20 minutes before calibration in order to achieve an atmosphere with 400 ppm CO₂. Wait until the CO₂ measured value is stable, then follow the steps above for calibration. After calibration, wait 10 minutes before starting normal operation.</p>
°C / °F	<p>°C/°F → Press ENTER → TEMP <small>°C</small></p> <p>→ Press ▲ / ▼ → TEMP <small>°F</small></p> <p>→ Press ENTER → °F</p> <p>→ Press ▲ / ▼ → TEMP <small>°C</small></p> <p>→ Press ENTER → °C</p>
	<p>This function allows you to switch between Celsius (°C) and Fahrenheit (°F) for the temperature display.</p>

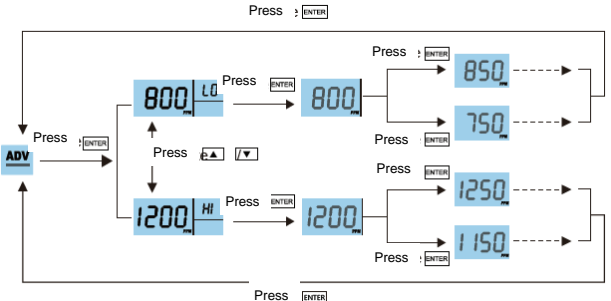
Function	Description
ADV	 <p>The flowchart illustrates the sequence of screens and user inputs for setting alarm limits:</p> <ul style="list-style-type: none"> Starts with the ADV screen. Press ENTER to proceed to the 800 LO screen. Press ENTER to proceed to the 800 screen. Press ENTER to proceed to the 850 screen. Press ENTER to proceed to the 750 screen. Press ENTER to proceed to the 1200 HI screen. Press ENTER to proceed to the 1200 screen. Press ENTER to proceed to the 1250 screen. Press ENTER to proceed to the 1150 screen. Press ENTER to return to the ADV screen. <p>Navigation between the 800 and 1200 screens is achieved using the up/down arrow keys.</p>
	<p>Use this function to set high and low alarm limits for Persons mode (0) and the first option in Plants mode (1). The high and low alarm limits for the options 2-9 in Plants mode cannot be set. See details on page 14. (Annex)</p>

Specifications

Typical test conditions: ambient temperature: 23 +/- 3°C, RH=50%~70%, altitude= 0~10 metres

Measurement	Specifications
Operating temperature	32°F ~ 122°F (0°C ~ 50°C)
Storage temperature	-4°F ~ 140°F (-20°C ~ 60°C)
Relative humidity	0-95% (non-condensing)
CO2 measurement	
Measuring range	0-5000 ppm
Display resolution	1 ppm (0-1000); 5 ppm (1000-2000); 10 ppm (>2000)
Precision	0~3000 ppm: ± 50 ppm ± 5% of the reading (take the max. value)
	(>3000) ppm: ± 7% of the reading
Repetition accuracy	20 ppm at 400 ppm
Temperature compensation	±0.1% of the reading per °C ±2 ppm per °C, referenced to 25°C
Reaction time	< 2 min for 63% of the level changes and < 4.6 min for 90%
Warm-up time	< 20 seconds

Temperature measurement	
Operating temperature	32°F ~ 195°F (0°C ~ 90°C)
Display resolution	0.1°F (0.1°C)
Reaction time	< 20 minutes (63%)
RH (relative humidity) measurement	
Measuring range	5 ~ 95%
Precision	±5%
Display resolution	1% main menu display, 0.1% max/min display
Operating voltage	5±0.25 V DC
Dimensions	120*90*35 mm
Weight	170 g (6.0 oz) (without AC adapter)

Annex

No.	Meaning	Value for high/low alarm	Variable
0	Persons mode	800-1200 ppm	Yes
1	User-defined plants	600-900 ppm	Yes
2	Beans	600-900 ppm	No
3	Chillies	800-1000 ppm	No
4	Cucumbers	1000-1500 ppm	No
5	Grapes	800-1400 ppm	No
6	Orchids	800-1400 ppm	No
7	Potatoes	1200-1800 ppm	No
8	Strawberries	800-1200 ppm	No
9	Tomatoes	800-1200 ppm	No